



L00160PL

POWER LED 160

■ SPECIFICATIONS

Identity No.	L00160PL
Capacity	160W
Input Voltage	220V/110V 15V - 30V DC
Input Current	0.8A @220V 50Hz 1.6A @110V 60Hz
Dimming Range	0% - 100%
Stirrup	Ø28mm (1-1/8 in.) Spigot
Class / IP Rating	1 / 22
Max. Ambient Temp.	50°C (122°F)
Weight	9.5 kg

■ DIMENSIONS (mm)

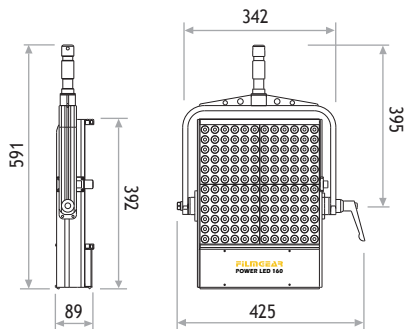

■ PHOTOMETRIC DATA

